



The Best Value Atomic Force Microscope

Park XE7

The most affordable research grade AFM
with flexible sample handling

www.parkAFM.com

Park
SYSTEMS



Park Systems The Most Accurate Atomic Force Microscope

Park XE7

The economical choice for innovative research

Park XE7 has all the state-of-the-art technology you've come to expect from Park Systems, at a price your lab can afford. Designed with the same attention to detail as our more advanced models, the XE7 allows you to do your research on time and within budget.

Uncompromised High Performance

Park XE7 provides accurate measurement at highest nanoscale resolution than any other products in its class. It allows you to obtain sample images and its characteristic measurements true to its nano structure thanks to its flat, orthogonal, and linear scan measurements by its unique AFM architecture: independent XY and Z, flexure based scans. Furthermore, Park's unique True Non-Contact™ mode provides you with the sharpest images, scan after scan without declining resolution.

For Current and Future Needs

Park XE7 empowers you to innovate now and in the future. It gives you ready access to the largest number of measurement modes in the industry. You can employ any of these modes now, and in the future to support your evolving needs. What's more, the XE7 has the most open access design in the market that allows you to integrate and combine accessories and instruments to tailor it to your unique research requirements.

Easy to Use and High Productivity

Park XE7 together with its intuitive graphical user interface, and its automated tools, allows even novice users get from sample placement to scan results, fast. Starting from pre-aligned tip mount, easy sample and tip exchange, simple laser alignment, on-axis top-down optical viewing, to user friendly scan controls and software processing, the XE7 provides highest research productivity in AFM.

Economical Beyond the System Cost

Not only is Park XE7 the most affordable as a research grade AFM, it is also the most economical in total cost of ownership. Park's True Non-Contact™ mode technology found in the XE7 allows users to save money on costly probe tips. Moreover, Park XE7 offers you much longer product life and upgradeability as a result of its compatibility with the most extensive types of modes and options available in the industry.



Park XE7

Innovative features for advanced research work

Accurate XY Scan by Crosstalk Elimination

- Two independent, closed-loop XY and Z flexure scanners for sample and probe tip
- Flat and orthogonal XY scan with low residual bow
- Out of plane motion of less than 2 nm over entire scan range
- Accurate height measurements without any need of software processing

Best Tip Life, Resolution and Sample Preservation by True Non-Contact™ Mode

- 10 times faster Z-servo speed than competing AFM piezo tube
- Less tip wear for prolonged high-quality and high-resolution imaging
- Minimized sample damage or modification
- Immune from parameter-dependent results observed in tapping imaging

The Most Extensible AFM Solution

- The most comprehensive range of SPM modes
- The largest number of sample measurement options
- The best option compatibility and upgradeability in the industry

The Best User Convenience by Design

- Open side access for easy sample or tip exchange
- Easy, intuitive laser alignment with pre-aligned tip mount
- Easy head removal by dovetail-lock mount
- Direct on-axis optics for high resolution optical viewing



Flat Orthogonal XY Scanning Without Scanner Bow

Park's Crosstalk Elimination removes scanner bow, allowing flat orthogonal XY scanning regardless of scan location, scan rate, and scan size. It shows no background curvature even on flattest samples, such as an optical flat, and with various scan offsets. This provides you with a very accurate height measurement and precision nanometrology for the most challenging problems in research and engineering.

Decoupled XY and Z Scanners

The fundamental difference between Park and its closest competitor is in the scanner architecture. Park's unique flexure based independent XY scanner and Z scanner design allows unmatched data accuracy in nano resolution in the industry.



Accurate Surface Measurement

"Flat" sample surface as it is!

- Low residual bow
- No need for software processing (raw data)
- Accurate results independent of scan location

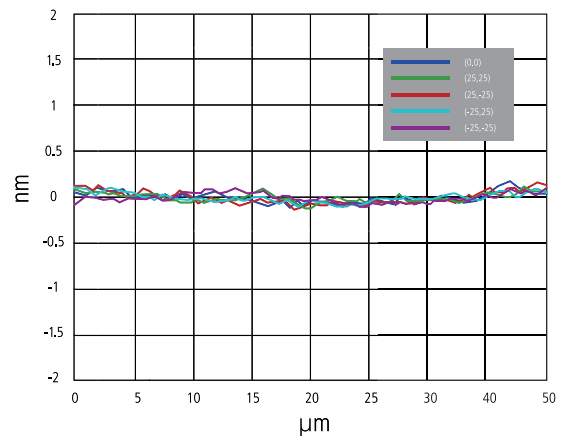
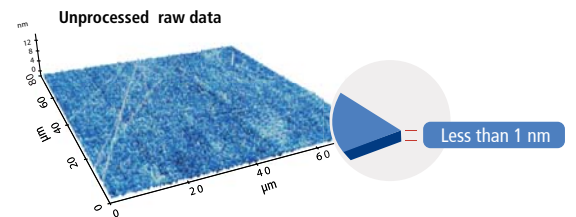

True Non-Contact™ Mode Preserves Tip Sharpness

AFM tips are so brittle that touching a sample will instantly reduce the resolution and quality of the image they produce. For soft and delicate samples, the tip will also damage the sample and result in inaccurate sample height measurements, something that can cost you valuable time and money.

True Non-Contact™ mode, a scan mode unique to Park AFMs, consistently produces high resolution and accurate data while maintaining the integrity of the sample.

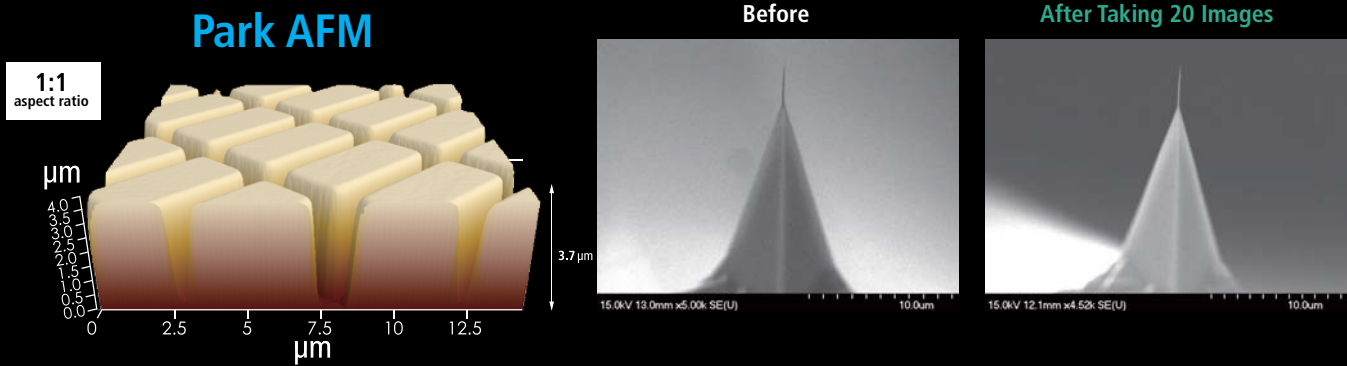

Accurate Feedback by Faster Z-servo enables True Non-Contact AFM

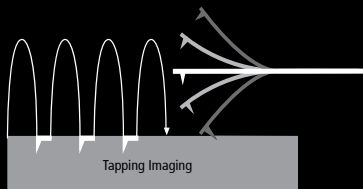

Tapping Imaging

- Quick tip wear = Blurred low-resolution scan
- Destructive tip-sample interaction = Sample damage and modification
- Highly parameter-dependent



True Non-Contact™ Mode

- Less tip wear = Prolonged high-resolution scan
- Non-destructive tip-sample interaction = Minimized sample modification
- Immunity from parameter dependent results

Park XE7

Equipped with innovative AFM technology

1 2D Flexure-Guided Scanner with 10 μm x 10 μm Scan Range

The XY scanner consists of symmetrical 2-dimensional flexure and high-force piezoelectric stacks provides high orthogonal movement with minimal out-of-plane motion as well as high responsiveness essential for precise sample scanning in the nanometer scale. The compact and rigid structure was designed for low noise, high speed servo response.

2 Flexure-Guided High Force Z Scanner

Driven by a high-force piezoelectric stack and guided by a flexure structure, its rigidity allows it to move at higher speeds in the vertical direction than the scanners used in conventional AFMs. The maximum Z scan range can be extended from 12 μm to 25 μm with the optional long range Z scanner (optional).

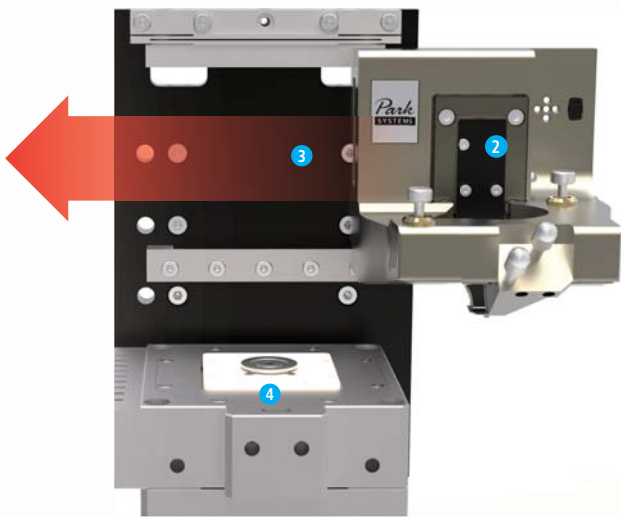

3 Slide-to-Connect SLD Head

The AFM head is easily inserted or removed by sliding it along a dovetail rail. The low coherency of the Super Luminescence Diode (SLD) enables accurate imaging of highly reflective surfaces and precise measurements for pico-Newton Force-distance spectroscopy. The SLD wavelength eliminates interference issues for users interested in combining the AFM with experiments in the visible spectrum.

4 Accessible Sample Holder

The unique head design can handle up to 100 mm sample size and allows for easy side access to the sample and tip.





5 Manual XY Sample Stage

The measurement location of the sample is easily and precisely controlled by the manual XY stage. The travel range of the XY sample stage is 13 mm x 13 mm.

6 Manual Optics Stage

The focus mechanism for the on-axis optics is adjusted manually.

Park XE Control Electronics with DSP Board in Controller

The nanoscale signals from the AFM are controlled and processed by the high performance Park XE electronics. With its low noise design and high speed processing unit, Park XE electronics successfully realize True Non-Contact™ mode ideal for nanoscale imaging as well as precise voltage and current measurement.

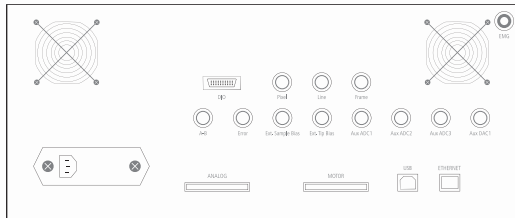

- High performance processing unit of 600 MHz and 4800 MIPS speed
- Low noise design for precise voltage and current measurement
- Versatile system to utilize various SPM techniques
- External Signal Access Module to access AFM input/output signals
- Maximum 16 data images
- Maximum data size: 4096 × 4096 pixels
- ADC/DAC in 16 bit, 500 kHz speed
- Electric noise isolation from PC by TCP/IP connection

Park XE7

Why the most affordable AFM is also accurate and easy to use

10 μm x 10 μm Flexure-Guided XY Scanner

The XY scanner consists of symmetrical 2-dimensional flexure and high-force piezoelectric stacks provides high orthogonal movement with minimal out-of-plane motion as well as high responsiveness essential for precise sample scanning in the nanometer scale.

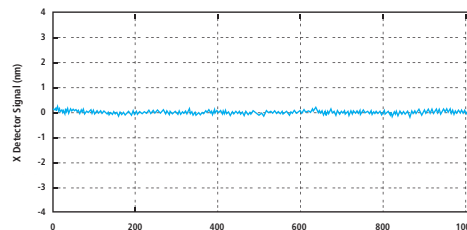

Direct On-Axis Optics

The intuitive direct on-axis sample view from the top allows you to navigate the sample surface easily to find the target area. A high-resolution digital camera with zoom capability allows clarity and great image quality regardless of panning motion.

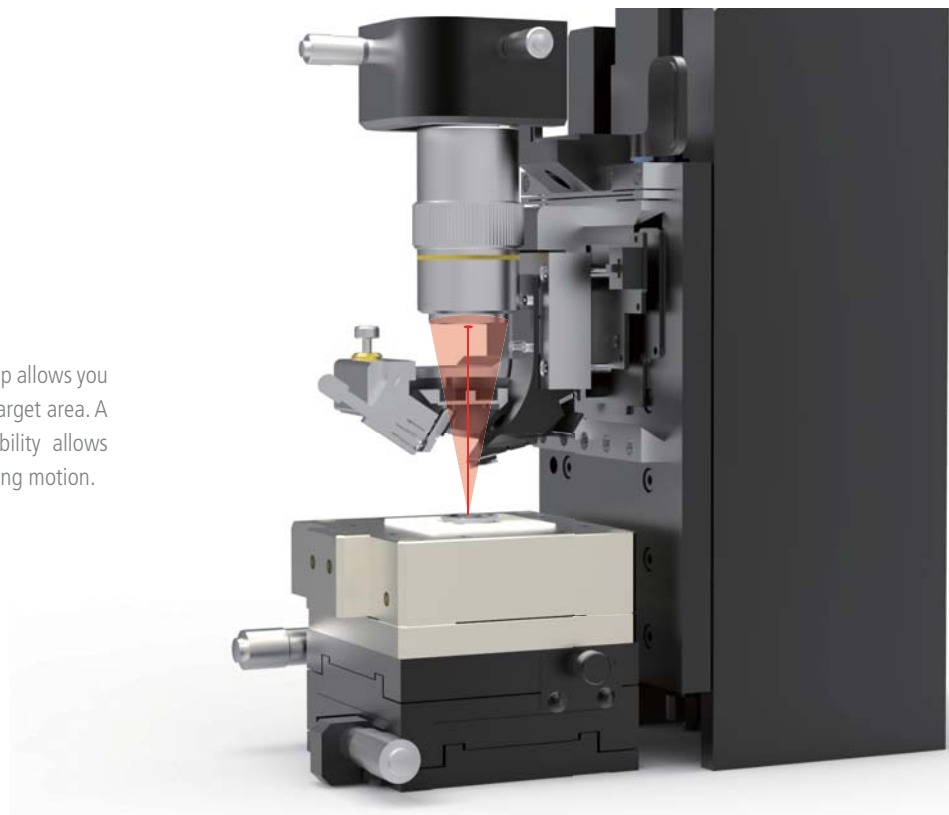

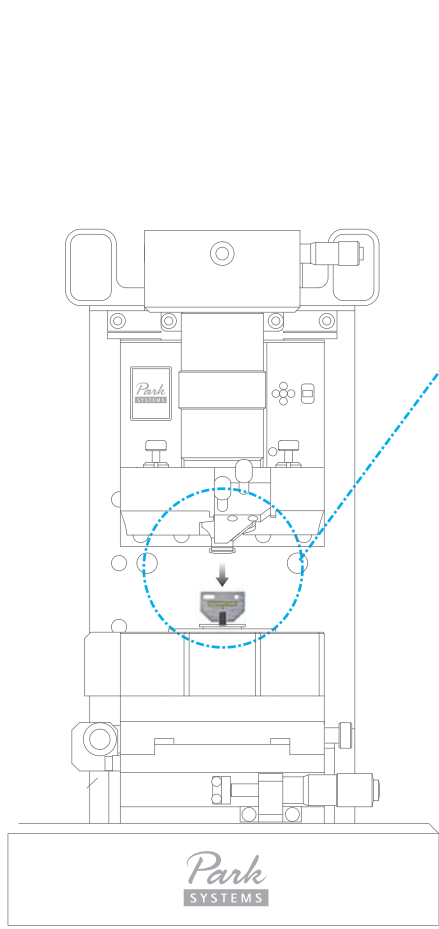

Easy Snap by Hand

Easy Tip and Sample Exchange

The unique head design allows easy side access allowing you to easily snap new tips and samples into place by hand. The cantilever is ready for scanning without the need for any tricky laser beam alignment by using pre-aligned cantilevers mounted on to the cantilever tip holder.

Easy, Intuitive Laser Beam Alignment

With our advanced pre-aligned cantilever holder, the **laser beam** is focused on the cantilever upon placement. Furthermore, the natural on-axis top-down view, the only one in the industry, allows you to easily find the laser spot. Since the laser beam falls vertically on the cantilever, you can intuitively move the laser spot along the X- and Y-axis by rotating its two positioning knobs. As a result, you can easily find the laser and position it on PSD using our beam alignment user interface. From there, all you will need is a minor adjustment to maximize the signal to start acquiring the data.



laser beam is always focused on the cantilever upon replacement

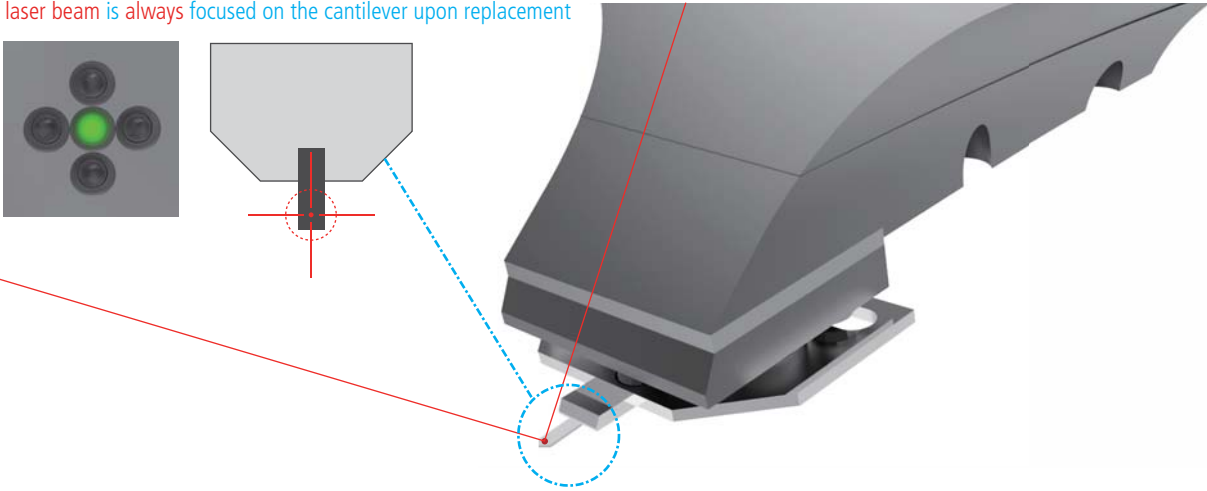

Park XE7

Supports Park's most extensive range of SPM modes and options in the industry

Today's researchers need to characterize a wide range of physical properties under diverse measurement conditions and sample environments. Park Systems provides the most extensive range of SPM modes, the largest number of AFM options, and the best option compatibility and upgradeability in the industry for advanced sample characterization.

Standard Imaging

- True Non-Contact AFM
- Basic Contact AFM
- Lateral Force Microscopy (LFM)
- Phase Imaging
- Intermittent (tapping) AFM

Chemical Properties

- Chemical Force Microscopy with Functionalized Tip
- Electrochemical Microscopy (EC-STM and EC-AFM)

Dielectric/Piezoelectric Properties

- Electric Force Microscopy (EFM)

Force Measurement

- Force Distance (F-D) Spectroscopy
- Force Volume Imaging
- Spring Constant Calibration by Thermal Method

Electrical Properties

- Conductive AFM
- I-V Spectroscopy
- Scanning Kelvin Probe Microscopy (SKPM/KPM)
- SKPM with High Voltage
- Scanning Capacitance Microscopy (SCM)
- Scanning Spreading-Resistance Microscopy (SSRM)
- Scanning Tunneling Microscopy (STM)
- Scanning Tunneling Spectroscopy (STS)
- Time-Resolved Photo Current Mapping (Tr-PCM)

Magnetic Properties

- Magnetic Force Microscopy (MFM)
- Tunable MFM

Mechanical Properties

- Force Modulation Microscopy (FMM)
- Nanoindentation
- Nanolithography
- Nanolithography with High Voltage
- Nanomanipulation
- Piezoresponse Force Microscopy (PFM)

Optical Properties

- Tip-Enhanced Raman Spectroscopy (TERS)
- Time-Resolved Photo Current Mapping (Tr-PCM)

Thermal Properties

- Scanning Thermal Microscopy (SThM)

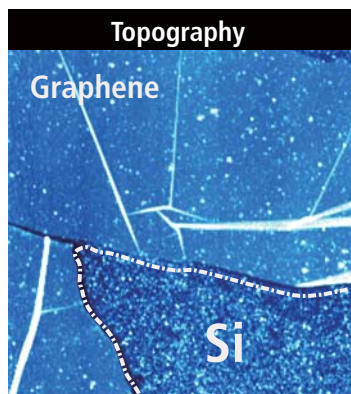

Sample: Graphene
Scan Size: 15 μm x 15 μm

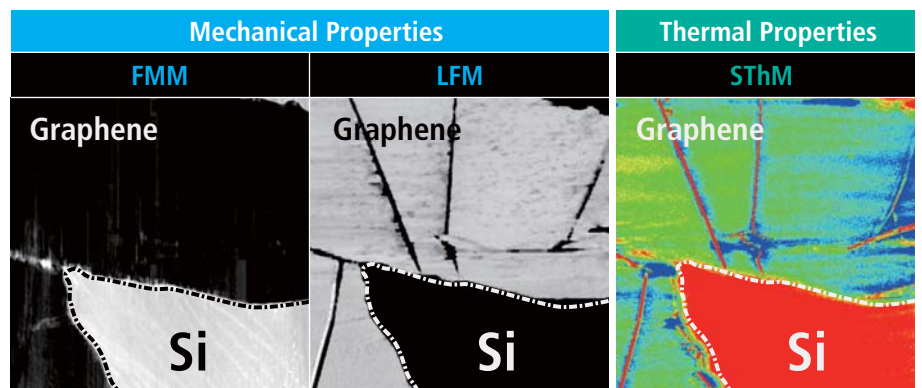
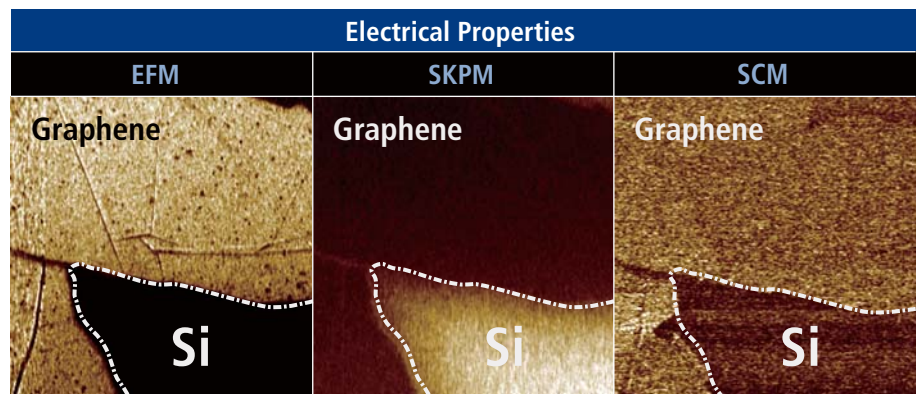

Options

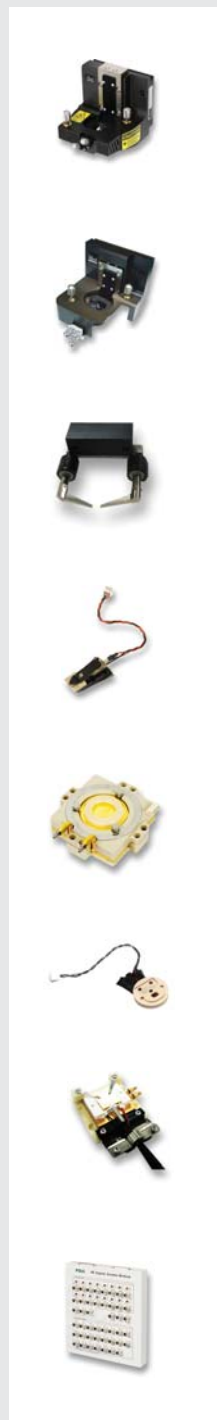

25 µm Z-scanner Head

- Z scan range: 25 µm
- Resonant frequency: 1.7 kHz
- Laser type: LD (650 nm) or SLD (830 nm)
- Noise floor: 0.03 nm (typical), 0.05 nm (maximum)

XE Optical Head

- Optical access: top and side
- Z scan range: 12 µm or 25 µm
- Resonant frequency: 3 kHz (12 µm XE Head), 1.7 kHz (25 µm XE Head)
- Laser type: LD (650 nm) or SLD (830 nm)
- Noise floor: 0.03 nm (typical), 0.05 nm (maximum)

Magnetic Field Generator

- Applies external magnetic field parallel to sample surface
- Tunable magnetic field
- Range: -300 to +300 gauss, -1500 to +1500 gauss
- Composed of pure iron core & two solenoid coils

Clip-type Probehead

- Can be used with unmounted cantilever
- Tip bias range: -10 V to +10 V
- Tip bias function available for EFM and Conductive AFM
- Support all the standard and advanced modes but STM, SCM, and in-liquid imaging

Liquid Cell

- Universal liquid cell
- Open or closed liquid cell with liquid/gas perfusion
- Temperature control range: 4 °C to +110 °C (in air), 4 °C to +70 °C (with liquid)
- Open/closed liquid cell
- Electrochemistry cell

Liquid Probehead

- Designed for imaging in general liquid environment
- Resistant to most buffer solutions including acid
- Contact and Non-contact AFM imaging in liquid

Temperature Control Stages

- Type 1: 0 °C to +180 °C
- Type 2: Ambient to +250 °C
- Type 3: Ambient to +600 °C

Signal Access Module (SAM)

- Enables access to various input/output signals for AFM
- Scanner driving signal for the XY and Z scanners
- Position signal for the XY and Z scanners
- Cantilever deflection signals of the vertical/lateral direction
- Bias signal for the sample and the cantilever
- Driving signal for XE7
- Auxiliary input signal to the system

XE-Heads	12 µm XE-Head	25 µm XE-Head	XE Optical Head	Hysitron Triboscope Adaptor Head
XY-Scanners	10 µm x 10 µm	50 µm x 50 µm	100 µm x 100 µm	
Probeheads	Clip-type Probehead	Liquid Probeheads (open/closed)	SCM Probehead	STM Probehead
Liquid Cells	Universal Liquid Cell	Open Liquid Cell	Electrochemistry Cell	
Environmental Control	Heating & Cooling Stage	Heating Stage	Environmental Chamber	Humidity Control System
Accessories	Signal Access Module	Q Controller	Magnetic Field Generator	Non-magnetic Sample Holder
	Cross-sectional Sample Holder	High Voltage Toolkit	Vacuum Chuck	

Park XE7

Specification

Scanner	XY scanner	Z scanner
	Single-module flexure XY scanner with closed-loop control Scan range: 100 μm \times 100 μm 50 μm \times 50 μm 10 μm \times 10 μm	Guided high-force Z scanner Scan range: 12 μm 25 μm

Vision	Sample Mount
Direct on-axis vision of sample surface and cantilever Coupled with 10 \times objective lens (20 \times optional) Field-of-view: 480 \times 360 μm CCD: 1 Mpixel	Sample size: Up to 100 mm Thickness: Up to 20 mm

Electronics	
High performance DSP: 600 MHz with 4800 MIPS Maximum 16 data images Maximum data size: 4096 \times 4096 pixels Signal inputs: 20 channels of 16 bit ADC at 500 kHz sampling Signal outputs: 21 channels of 16 bit DAC at 500 kHz settling Synchronous signal: End-of-image, end-of-line, and end-of-pixel TTL signals	Active Q control (optional) Cantilever spring constant calibration (optional) CE Compliant Power: 120 W Signal Access Module (Optional)

Options/Modes	Standard Imaging	Chemical Properties	Dielectric/Piezoelectric Properties
	<ul style="list-style-type: none"> • True Non-Contact AFM • Basic Contact AFM • Lateral Force Microscopy (LFM) • Phase Imaging • Intermittent (tapping) AFM 	<ul style="list-style-type: none"> • Chemical Force Microscopy with Functionalized Tip • Electrochemical Microscopy (EC-STM and EC-AFM) 	<ul style="list-style-type: none"> • Electric Force Microscopy (EFM) • Dynamic Contact EFM (DC-EFM) • Piezoelectric Force Microscopy (PFM) • PFM with High Voltage

Force Measurement	Magnetic Properties	Optical Properties
<ul style="list-style-type: none"> • Force Distance (F-D) Spectroscopy • Force Volume Imaging 	<ul style="list-style-type: none"> • Magnetic Force Microscopy (MFM) • Tunable MFM 	<ul style="list-style-type: none"> • Tip-Enhanced Raman Spectroscopy (TERS) • Time-Resolved Photo Current Mapping (Tr-PCM)

Electrical Properties	Mechanical Properties	Thermal Properties
<ul style="list-style-type: none"> • Conductive AFM • I-V Spectroscopy • Scanning Kelvin Probe Microscopy (SKPM/KPM) • SKPM with High Voltage • Scanning Capacitance Microscopy (SCM) • Scanning Spreading-Resistance Microscopy (SSRM) • Scanning Tunneling Microscopy (STM) • Time-Resolved Photo Current Mapping (Tr-PCM) 	<ul style="list-style-type: none"> • Force Modulation Microscopy (FMM) • Nanoindentation • Nanolithography • Nanolithography with High Voltage • Nanomanipulation • Piezoelectric Force Microscopy (PFM) 	<ul style="list-style-type: none"> • Scanning Thermal Microscopy (SThM)

Accessories
Electrochemistry Cell Universal Liquid Cell with Temperature Control Sample Stages with Temperature Control Magnetic Field Generator

Stage

XY travel range: 13 × 13 mm
Z travel range: 29.5 mm
Focus travel range: 70 mm

Software

XEP

Dedicated system control and data acquisition software
Adjusting feedback parameters in real time
Script-level control through external programs (optional)

XEI

AFM data analysis software (running on Windows, MacOS X, and Linux)

Dimensions in mm

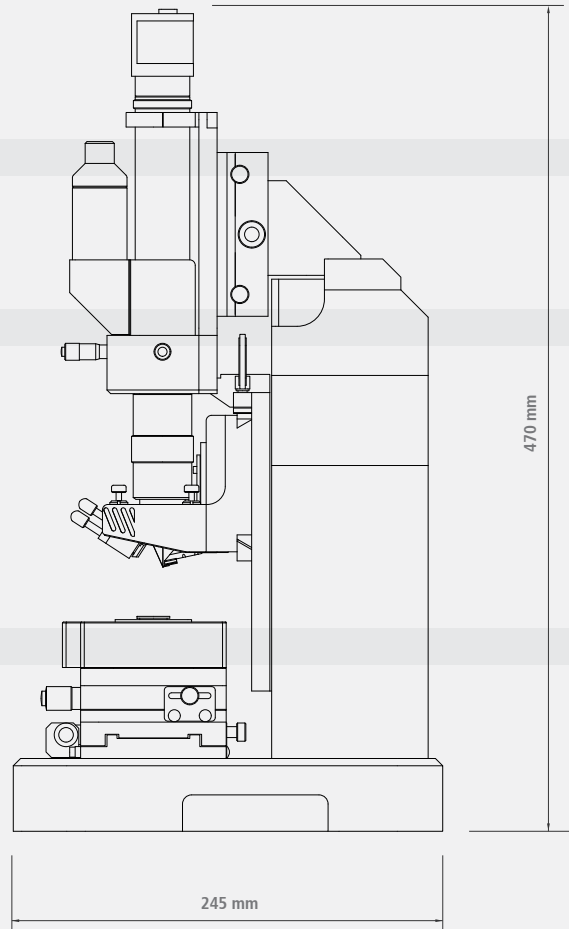
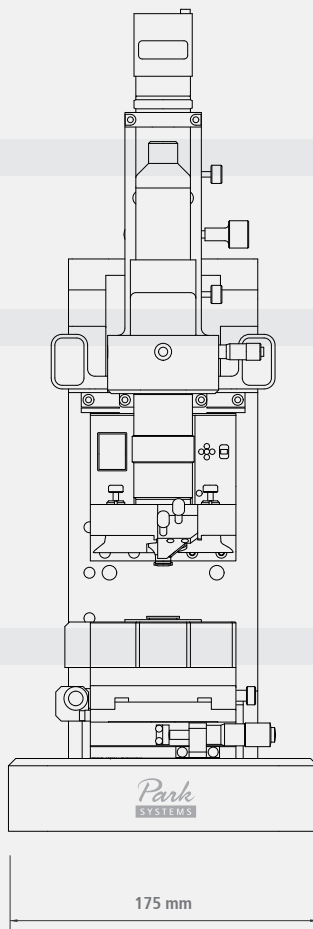

Park Systems

Dedicated to producing the most accurate and easiest to use AFMs

The global headquarters is located at
Korean Advanced Nanotechnology Center (KANC) in Suwon, Korea.



More than a quarter century ago, the foundations for Park Systems were laid at Stanford University where Dr. Sang-il Park, the founder of Park Systems worked as an integral part of the group that first developed AFM technology. After perfecting the technology, he then went on to create the first commercial AFM and later Park Systems was born.

Park Systems strives everyday to live up to the innovative spirit of its beginnings. Throughout our long history, we have honored our commitment to providing the most accurate and yet very easy to use AFMs, with revolutionary features like True Non-Contact™ mode, and many automated software tools. We are not simply content to rest on our past success. All of our products are designed with same care and creativity that went into our first, allowing you to focus on getting results without worrying about the integrity of your tools.



www.parkAFM.com

HEADQUARTERS

GLOBAL HEADQUARTERS: +82-31-546-6800
AMERICAS HEADQUARTERS: +1-408-986-1110
JAPAN HEADQUARTERS: +81-3-3219-1001
SE ASIA HEADQUARTERS: +65-6634-7470

OCEANIA

Australia and New Zealand: +61-2-9319-0122

ASIA

China: +86-10-6401-0651
India: +91-40-655-88-501
Indonesia: +62-21-5698-2988
Malaysia: +603-8065-3889
Philippines: +632-239-5414
Saudi Arabia: +966-2-640-5846
Taiwan: +886-2-8227-3456
Thailand: +662-668-2436
UAE: +971-4-339-2603
Vietnam: +844-3556-7371

EUROPE

France: +33-1-6953-8023
Germany: +49-6103-30098-0
Italy: +39-02-9009-3082
Israel: +972-3-923-9666
Switzerland: +41-22-788-9186
Romania: +40-21-313-5655
Russia: +7 (495) 22-11-208
Spain and Portugal: +34-902-244-343
Turkey: +90-312-236-42-0708
UK and Ireland: +44(0)1372-378-822
Benelux, Scandinavia, and Baltics: +31-184-64-0000

AMERICAS

USA: +1-408-986-1110
Canada: +1-888-641-0209
Brazil: +55-11-4178-7070
Colombia: +57-347-0060
Ecuador: +593-2-284-5287

Park
SYSTEMS